

Panasonic



60-inch class Full High Definition Plasma Display

TH-60PF30U TENTATIVE

● Product specification (design and specification subject to change without notice)

■ DISPLAY

Screen Size (Diagonal)	60.1-inch (1,526 mm)
Aspect ratio	16:9
Effective Display Area (W x H)	52.3" x 29.4" (1,330 x 748 mm)
Number of pixels (H x V)	1,920 x 1,080 pixels (1 pixel=3cells for R, G and B)
Pixel Pitch (H x V)	0.693 x 0.693 mm
Contrast Ratio	5,000,000 :1
Gradation	6,144 steps (equivalent)
Panel Life ^{*1}	approx. 100,000 hours
Full HD 3D	3D Full HD Ready ^{*2}

*1: Guideline operating hours before the panel brightness is reduced to half when the panel is used to display motion pictures in the Standard mode. Afterimages (burned-in images) and malfunctions are not taken into consideration.
*2: An optional 3D IR Transmitter and 3D Eyewear are required for viewing 3D images.

■ CONNECTION TERMINAL

VIDEO IN	BNC x 1	1.0 V [p-p] (75 Ω)
AUDIO IN (L/R)	RCA x 1 set	0.5 V [rms]
COMPONENT/RGB IN	BNC x 3	Y/G : with sync 1.0 V [p-p] (75 Ω) B/Pb/Cb, R/Pr/Cr : 0.7 V [p-p] (75 Ω)
AUDIO IN (L/R)	RCA x 1 set	0.5 V [rms]
HDMI IN	HDMI TYPE A connector x 1	
DVI-D IN	DVI-D 24pin x 1	Compliance with DVI Revision 1.0 Compatible with HDCP 1.1
AUDIO IN	M3 jack x 1 (Common use with PC)	0.5 V [rms]
PC IN	MINI D-SUB 15pin x1 (Female)	Y/G : with sync 1.0 V [p-p] (75 Ω) without sync 0.7 V [p-p] (75 Ω) B/Pb/Cb, R/Pr/Cr : 0.7 V [p-p] (75 Ω)
AUDIO IN	M3 jack x 1 (Common use with DVI-D)	HD/VD : 1.0~5.0 V [p-p] (high impedance) 0.5 V [rms]
Function Slot:SLOT 2.0	1 (Vacant)	

■ CONTROL TERMINAL

LAN	RJ45 10 BASE-T/100 BASE-TX, Compatible with PJ Link
SERIAL	D-SUB 9pin x 1 (EXTERNAL CONTROL TERMINAL), RS-232C Compatible
3D shutter out	M3 jack x 1 (for 3D IR Transmitter)
DC 8V out for 3D IR Transmitter	Center Plus for EIAJ 4 mm Plug

■ ELECTRICAL

Power Requirements	110-127 V AC, 50 Hz/60 Hz
Power Consumption	510 W
On Mode Average Power Consumption ^{*2}	T.B.D
Power off condition	0.2 W
Stand-by condition	Save ON 0.4 W, Save OFF 0.7 W

*2: Based on IEC 62087 Ed.2 measurement method.

■ SOUND

Audio Output	6Ω, 16 W [8 W + 8 W] (10 % THD)
--------------	---------------------------------

■ MECHANICAL

Dimensions (W x H x D)	56.5" x 33.6" x 3.9" (1,434 × 852 × 99 mm)
Carton Dimensions (W x H x D)	63.4" x 39.7" x 13.1" (1,611 × 1,008 × 334 mm)
Weight	approx. 108.1 lbs. (49.0 kg)
Gross weight	approx. 136.7 lbs. (62.0 kg)
Cabinet Color	Black

■ ENVIRONMENTAL

Operating environment	Temperature: 32 °F to 104 °F (0 °C to 40 °C)
	Humidity : 20 % to 80 % (Non condensation)
	Altitude : 0 to 9,100 feet (0 to 2,800 m)
Storage environment	Temperature: -4 °F to 140 °F (-20 °C to 60 °C)
	Humidity : 20 % to 90 % (Non condensation)
	Altitude : 0 to 10,800 feet (0 to 3,300 m)

■ STANDARD (CERTIFICATIONS)

SAFETY REGULATIONS	UL60065, CAN/CSA-22.2 No 60065:03, NOM approval
RADIATION REGULATIONS	FCC Part 15 Class-B, ICES-003
Energy star 5.0, CEC	Yes

■ REMOTE CONTROL TRANSMITTER

Power Requirements	DC 3 V (2 x AA Size batteries)
Operation distance	approx. 23 ft (7 m) in front of plasma display
Weight	approx. 3.5 oz (100 g) including batteries

INCLUDED ACCESSORIES	- AC power cord - Operating instruction book - CD-ROM (Operating instruction) - Remote control transmitter - Batteries - Clamper x 1 - Ferrite core x 2
----------------------	--

UPC Code	885170043275
----------	--------------

● MAIN FEATURE

Digital Zoom	Yes
Portrait Zoom	Yes
Video Wall	Yes (N x M, up to 5 x 5)
1 : 1Pixel Mode	Yes
Display size setting	Yes
Auto Set Up	Yes
Picture profile (Memory save)	Yes
HDMI Range	Yes
Screen Saver	Negative image, Scrolling bar only, White screen, Overlay scrolling bar
NANO DRIFT Saver	Yes (LOW/MID/HIGH)
Side Bar Adjust	Yes
Peak Limit	Yes
Power Save	Yes
Stand By Save	Yes
Power Management (PC/DVI)	Yes
No Signal Power Off	Yes
Weekly Command Timer	Yes
Audio Input Select	Yes
Studio Mode (W/B, Gain)	Yes
Initial INPUT/VOL Level	Yes
INPUT/Button Lock	Yes
Remote-control User Level	Yes
Maximum VOL level	Yes

● OPTIONAL ACCESSORIES

Pedestal	TY-ST58P20
Wall-hanging bracket (vertical/angled)	TY-WK65PR20
Mobile stand	TY-ST58PF20
Speakers	TY-SP58P10WK
Touch Panel	TY-TP60P30K
3D IR Transmitter	TY-3D30TRW
3D Eyewear	TY-EW3D2LU TY-EW3D2MU TY-EW3D2SU
Dual HD-SDI Terminal Board with 3D signal	TY-FB30DHD3D
Dual DVI-D Terminal Board with 3D signal	TY-FB30DD3D
BNC Dual Video Terminal Board	TY-FB9BD
DVI-D Terminal Board	TY-FB11DD
Dual HDMI Terminal Board	TY-FB10HMD
HD-SDI Terminal Board	TY-FB9HD
HD-SDI with Audio Terminal Board	TY-FB10HD
Dual link HD-SDI Terminal Board	TY-FB11DHD

● DIMENSIONS

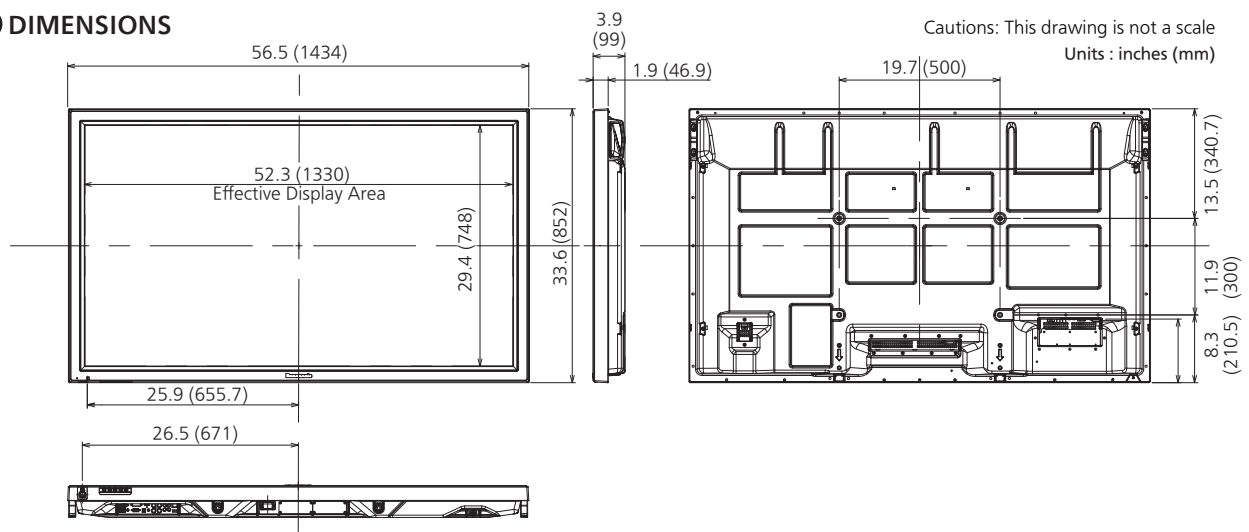

● TERMINAL DIMENSIONS

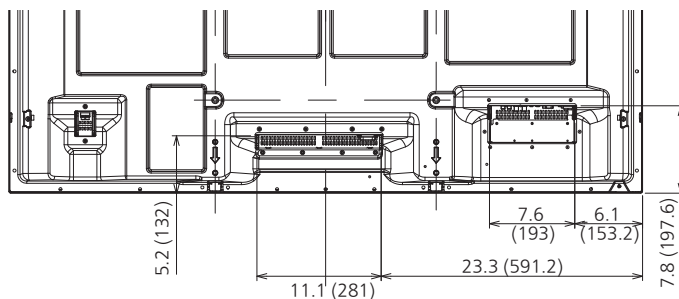

● CONNECTION TERMINAL

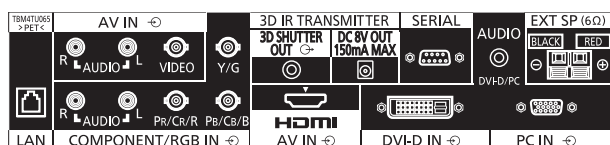

● Applicable Input Signals

* Mark: Applicable input signal

	Signal name	Horizontal frequency (kHz)	Vertical frequency (Hz)	COMPONENT / RGB IN / PC IN (Dot clock (MHz))	DVI-D IN (Dot clock (MHz))	HDMI
1	525 (480) / 60i	15.73	59.94	* (13.5)	* (27.0)	*
2	525 (480) / 60p	31.47	59.94	* (27.0) *5	* (27.0)	*
3	625 (575) / 50i	15.63	50.00	* (13.5)		
4	625 (576) / 50i	15.63	50.00		* (27.0)	*
5	625 (575) / 50p	31.25	50.00	* (27.0)		
6	625 (576) / 50p	31.25	50.00		* (27.0)	*
7	750 (720) / 60p	45.00	60.00	* (74.25)	* (74.25)	*
8	750 (720) / 50p	37.50	50.00	* (74.25)	* (74.25)	*
9	1,125 (1,080) / 60p	67.50	60.00	* (148.5) *1	* (148.5)	*
10	1,125 (1,080) / 60i	33.75	60.00	* (74.25) *1	* (74.25)	*
11	1,125 (1,080) / 50p	56.26	50.00	* (148.5) *1	* (148.5)	*
12	1,125 (1,080) / 50i	28.13	50.00	* (74.25) *1	* (74.25)	*
13	1,125 (1,080) / 24sF	27.00	48.00	* (74.25) *2		
14	1,125 (1,080) / 30p	33.75	30.00	* (74.25) *1	* (74.25)	
15	1,125 (1,080) / 25p	28.13	25.00	* (74.25) *1	* (74.25)	
16	1,125 (1,080) / 24p	27.00	24.00	* (74.25) *1	* (74.25)	*
17	1,250 (1,080) / 50i	31.25	50.00	* (74.25) *3		
18	2,048 × 1,080 / 24sF *7	27.00	48.00			
19	2,048 × 1,080 / 24p *7	27.00	24.00			
20	640 × 400 @70 Hz	31.46	70.07	* (25.17)		
21	640 × 480 @60 Hz	31.47	59.94	* (25.18) *6	* (25.18)	*
22	640 × 480 @72 Hz	37.86	72.81	* (31.5)		
23	640 × 480 @75 Hz	37.50	75.00	* (31.5)		
24	640 × 480 @85 Hz	43.27	85.01	* (36.0)		
25	800 × 600 @56 Hz	35.16	56.25	* (36.0)		
26	800 × 600 @60 Hz	37.88	60.32	* (40.0)	* (40.0)	*
27	800 × 600 @72 Hz	48.08	72.19	* (50.0)		
28	800 × 600 @75 Hz	46.88	75.00	* (49.5)		
29	800 × 600 @85 Hz	53.67	85.06	* (56.25)		
30	852 × 480 @60 Hz	31.47	59.94	* (33.54) *6	* (34.24)	*
31	1,024 × 768 @50 Hz	39.55	50.00		* (51.89)	*
32	1,024 × 768 @60 Hz	48.36	60.00	* (65.0)	* (65.0)	*
33	1,024 × 768 @70 Hz	56.48	70.07	* (75.0)		
34	1,024 × 768 @75 Hz	60.02	75.03	* (78.75)		
35	1,024 × 768 @85 Hz	68.68	85.00	* (94.5)		
36	1,066 × 600 @60 Hz	37.64	59.94	* (53.0)	* (53.0)	*
37	1,152 × 864 @60 Hz	53.70	60.00		* (81.62)	*
38	1,152 × 864 @75 Hz	67.50	75.00	* (108.0)		
39	1,280 × 768 @60 Hz	47.70	60.00	* (80.14)		
40	1,280 × 960 @60 Hz	60.00	60.00	* (108.0)		
41	1,280 × 960 @85 Hz	85.94	85.00	* (148.5)		
42	1,280 × 1,024 @60 Hz	63.98	60.02	* (108.0)	* (108.0)	*
43	1,280 × 1,024 @75 Hz	79.98	75.03	* (135.0)		
44	1,280 × 1,024 @85 Hz	91.15	85.02	* (157.5)		
45	1,366 × 768 @50 Hz	39.55	50.00		* (69.92)	*
46	1,366 × 768 @60 Hz	48.36	60.00	* (86.71)	* (87.44)	*
47	1,400 × 1,050 @60 Hz	65.22	60.00		* (122.61)	*
48	1,600 × 1,200 @60 Hz	75.00	60.00	* (162.0)	* (162.0)	*
49	1,600 × 1,200 @65 Hz	81.25	65.00	* (175.5)		
50	1,920 × 1,080 @60 Hz	67.50	60.00	* (148.5) *4	* (148.5)	*
51	1,920 × 1,200 @60 Hz	74.04	59.95		* (154.0)	*
52	Macintosh13" (640 × 480)	35.00	66.67	* (30.24)		
53	Macintosh16" (832 × 624)	49.72	74.54	* (57.28)		
54	Macintosh21" (1,152 × 870)	68.68	75.06	* (100.0)		

* 1: Based on SMPTE 274M standard.

* 2: Based on SMPTE RP211 standard.

* 3: Based on SMPTE 295M standard.

* 4: The input signal is recognized as 1,125 (1,080) / 60p.

* 5: When selected the RGB format and 525p signal input to the PC IN terminal, it is recognized as VGA 60Hz signal.

* 6: When inputted VGA 60Hz format signal from the other than PC IN terminal, it is recognized as 525p signal.

* 7: Based on SMPTE 292M and 372M standards. These signals can be received when the Dual Link HD-SDI Terminal Board (TY-FB11DHD) is installed.

Note: Signals without above specification may not be displayed properly.

Pin assignments and signal names

Serial Terminals Connection : D-sub 9-Pin

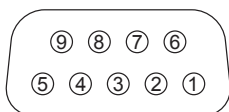

Pin No.	Details
②	R X D
③	T X D
⑤	GND
④ • ⑥	Non use
⑦	⌋ (Shorted in this set)
⑧	
① • ⑨	NC

These signal names are those of computer specifications.

Communication parameters

Signal level	RS-232C compliant
Synchronization method	Asynchronous
Baud rate	9600 bps
Parity	None
Character length	8 bits
Stop bit	1 bit
Flow control	-

PC Input Terminals Connection : Mini D-sub 15-Pin

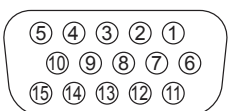

Pin No.	Signal Name	Pin No.	Signal Name	Pin No.	Signal Name
①	R (P _R /C _R)	⑥	GND (Ground)	⑪	NC (not connected)
②	G (Y)	⑦	GND (Ground)	⑫	SDA
③	B (P _B /C _B)	⑧	GND (Ground)	⑬	HD/SYNC
④	NC (not connected)	⑨	+5 V DC	⑭	VD
⑤	GND (Ground)	⑩	GND (Ground)	⑮	SCL

HDMI connection

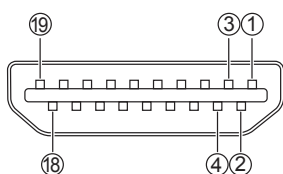

Pin No.	Signal Name	Pin No.	Signal Name
①	T.M.D.S Data2+	⑪	T.M.D.S Clock Shield
②	T.M.D.S Data2 Shield	⑫	T.M.D.S Clock-
③	T.M.D.S Data2-	⑬	CEC
④	T.M.D.S Data1+	⑭	Reserved (N.C. on device)
⑤	T.M.D.S Data1 Shield		
⑥	T.M.D.S Data1-	⑮	SCL
⑦	T.M.D.S Data0+	⑯	SDA
⑧	T.M.D.S Data0 Shield	⑰	DDC/CEC Ground
⑨	T.M.D.S Data0-	⑱	+5V Power
⑩	T.M.D.S Clock+	⑲	Hot Plug Detect

DVI-D IN connection

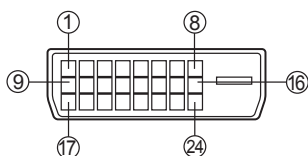

Pin No.	Signal Name	Pin No.	Signal Name
①	T.M.D.S. data 2-	⑬	_____
②	T.M.D.S. data 2+	⑭	+5 V DC
③	T.M.D.S. data 2 shield	⑮	Ground
④	_____	⑯	Hot plug detect
⑤	_____	⑰	T.M.D.S. data 0-
⑥	DDC clock	⑱	T.M.D.S. data 0+
⑦	DDC data	⑲	T.M.D.S. data 0 shield
⑧	_____	⑳	_____
⑨	T.M.D.S. data 1-	㉑	_____
⑩	T.M.D.S. data 1+	㉒	T.M.D.S. clock shield
⑪	T.M.D.S. data 1 shield	㉓	T.M.D.S. clock+
⑫	_____	㉔	T.M.D.S. clock-